

Step-up converter for cell phone camera flash LEDs

General features

- Supply voltage range: 2.6V to 5.5V
- 17V Maximum output voltage
- Two current levels up to 300mA set with external resistors
- Dedicated pin to select the required level of current
- Operating frequency: 1.5MHz: PWM Controller
- Torch mode supported
- Shutdown pin with true load disconnection
- Efficiency: 90% at 100mA; 80% at 300mA
- DFN10L (3mm x 3mm) Package

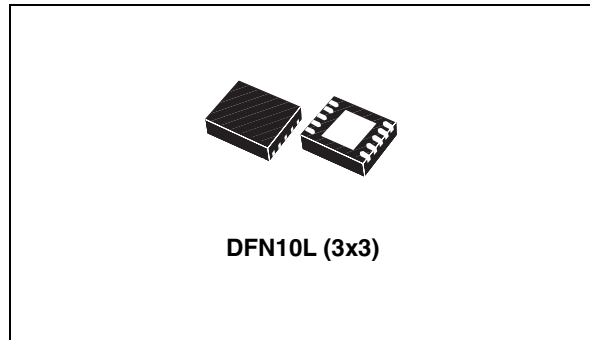

Description

The STCF01 is a dedicated IC designed to drive two, three, or four white, cell phone camera flash LEDs with constant current. The step-up (boost) converter input is connected directly to the battery, and its converter output voltage is automatically determined using current feedback-based duty cycle control.

The STCF01 has a dedicated pin for two levels of LED current selection. An external resistor is used

to set the required current for each level. Compared to the linear current control technique, this method allows designers to achieve the best and most efficient performance possible with the selected current, thereby avoiding linear element losses.

The Shutdown (SHDN) pin saves power when the camera flash is not used by consuming less than 0.1µA of current. When the SHDN pin is high (logic '1'), the device is turned OFF and there is no DC current path from the supply to the white LEDs (Load Disconnect). If it is held to GND, the output current continuously flows through the LEDs (Torch mode). The SHDN pin, when it is set to low (logic '0'), is also used to set the flash function time duration.

Order code

Part number	Package	Packaging
STCF01PMR	DFN10L (3mm x 3mm)	4500 parts per reel

Contents

1	Diagram	3
2	Pin configuration	4
3	Application information	5
4	Maximum ratings	6
5	Electrical characteristics	7
6	Detailed description	8
7	Typical operating characteristics	9
8	Package mechanical data	12
9	Revision history	15

1 Diagram

Figure 1. Block diagram

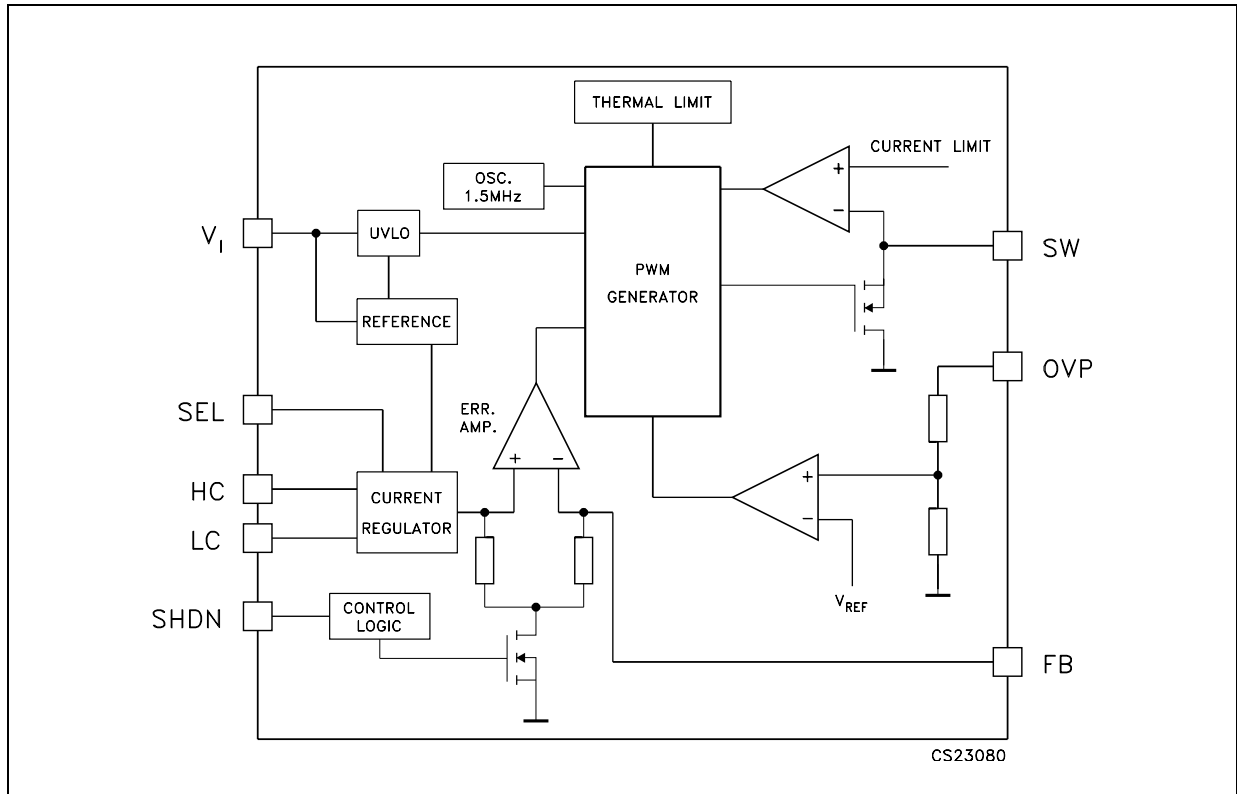

2 Pin configuration

Figure 2. Pin connections (top view)

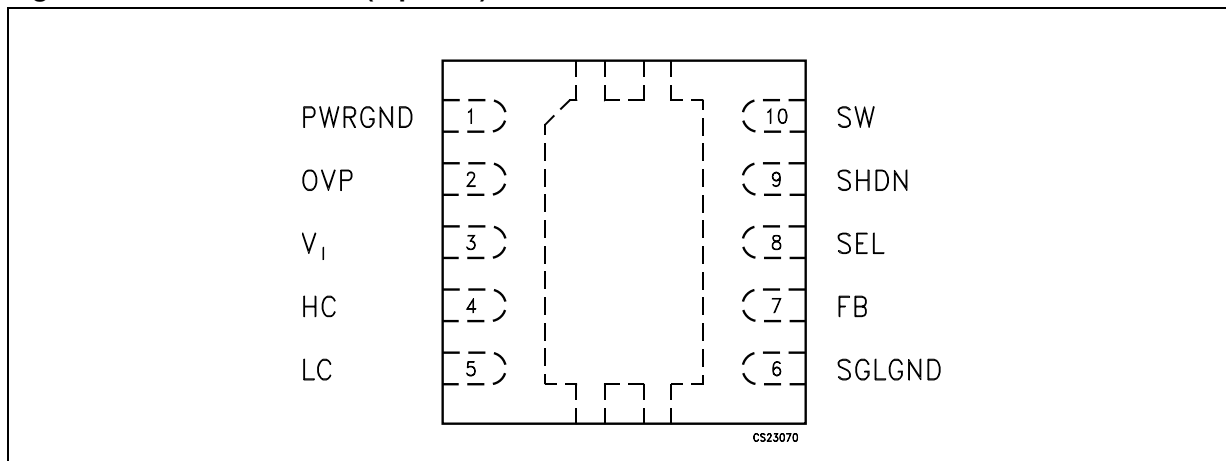
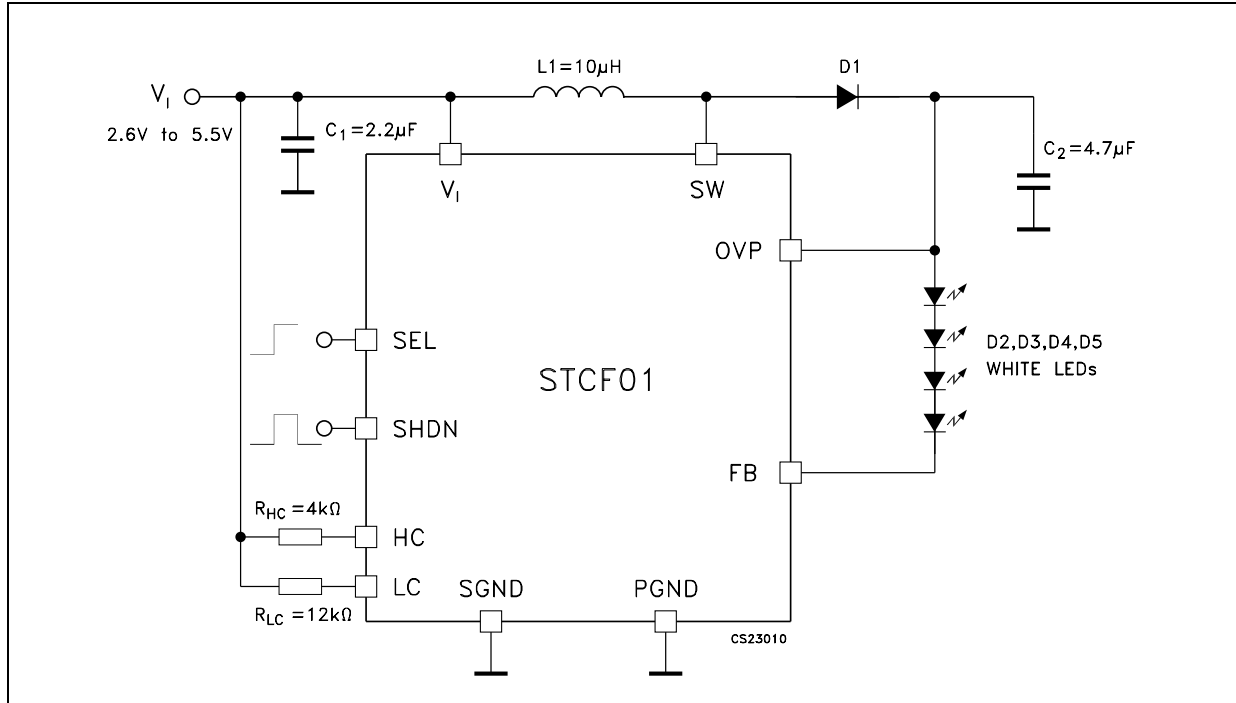

Table 1. Pin description

Pin N°	Symbol	Note
1	PWRGND	This is the application power signal reference. Connect the input and output capacitors to this pin.
2	OVP	This pin senses step-up output voltage, which provides overvoltage protection in the event that the output voltage exceeds the OVP threshold
3	V_I	This pin supplies the input voltage for the step-up stage as well as the supply voltage for the overall device.
4	HC	This pin sets the high level current for the white LEDs with a resistor that is connected between this pin and V_I .
5	LC	This pin sets the low level current for the white LEDs with a resistor that is connected between this pin and V_I .
6	SGLGND	This pin is the logic signal reference for the IC.
7	FB	This pin senses the current flowing through the white LEDs and uses this feedback to provide current regulation.
8	SEL	This pin is used to select the signal level of the white LEDs; a low level signal sets the low level LED current, while the high level signal sets the high level LED current.
9	SHDN	This pin enables or disables the Shutdown mode. A high level signal enables device Shutdown mode, where most of the device internal logic is turned OFF. If this pin is held to GND, the output current flows through the LEDs continuously (Torch mode).
10	SW	This is the switch node pin, which is connected to the internal N-channel MOSFET drain.

3 Application information

Figure 3. Application circuit



4 Maximum ratings

Table 2. Absolute maximum ratings

Symbol	Parameter	Value	Unit
V_I	DC Input Voltage to SGLGND	-0.3 to 6	V
V_{SW}	Switch Voltage	-0.3 to 20	V
FB, SEL, SHDN, LC, HC	Voltage Range	-0.3 to $V_I + 0.3$	V
OVP	Over Voltage Protection	-0.3 to 20	V
ESD	Human Body Model	± 2	kV
P_{TOT}	Continuous Power Dissipation (at $T_A = 70^\circ\text{C}$)	500	mW
T_{OP}	Operating Junction Temperature Range	-40 to 85	$^\circ\text{C}$
T_J	Junction Temperature	-40 to 125	$^\circ\text{C}$
T_{STG}	Storage Temperature Range	-65 to 150	$^\circ\text{C}$

Note: Absolute Maximum Ratings are those values beyond which damage to the device may occur. Functional Operation under these conditions is not implied.

Table 3. Thermal data

Symbol	Parameter	Value	Unit
R_{thJA}	Thermal Resistance Junction-Ambient	30.9	$^\circ\text{C}/\text{W}$
R_{thJC}	Thermal Resistance Junction-Case	2.96	$^\circ\text{C}/\text{W}$

5 Electrical characteristics

Table 4. DC Electrical characteristics

($T_J = -40^{\circ}\text{C}$ to 85°C , $V_I = 3.6\text{V}$, $C_I = 2.2\mu\text{F}$, $C_O = 4.7\mu\text{F}$, $L = 10\mu\text{H}$, $R_{LC} = 12\text{k}\Omega$, $R_{HC} = 4\text{k}\Omega$, $V_{OVP} = 8\text{V}$, Typ. values @ 25°C , unless otherwise specified)

Symbol	Parameter	Test Conditions	Min.	Typ.	Max.	Unit
General section						
V_I	Max Operation Supply Voltage				5.5	V
V_{UVLO}	Under Voltage lockout threshold	$V_{SEL} = 0\text{V}$, $V_{SHDN} = 0\text{V}$, Min. duty cycle	2.3	2.45	2.6	V
I_Q	Quiescent Current	$V_{SEL} = 0\text{V}$		2.3	3	mA
		Shutdown Mode		0.1	0.5	μA
f_{SW}	Switching Frequency	$V_{SEL} = 0\text{V}$, $V_{SHDN} = 0\text{V}$	1.2	1.5	1.8	MHz
V_{OVP}	Over Voltage Threshold	No Load	17	18	19	V
I_{PKMax}	Maximum Inductor Current	$V_{SHDN} = 0\text{V}$		1.2		A
Current control						
V_{HC}	HC Pin Voltage	$V_{SEL} = 3\text{V}$, $V_{SHDN} = 0\text{V}$	$V_I - 0.65$	$V_I - 0.6$	$V_I - 0.55$	V
V_{LC}	LC Pin Voltage	$V_{SEL} = 0\text{V}$, $V_{SHDN} = 0\text{V}$	$V_I - 0.65$	$V_I - 0.6$	$V_I - 0.55$	V
I_{LED}/I_{HC}	High Level Current Multiplier	$V_{SEL} = 3\text{V}$, $V_{SHDN} = 0\text{V}$ (25°C)	1900	2100	2300	A/A
I_{LED}/I_{LC}	Low Level Current Multiplier	$V_{SEL} = 0\text{V}$, $V_{SHDN} = 0\text{V}$ (25°C)	2200	2400	2600	A/A
R_{ONFB}	Resistance ON Feedback	$I_{FB} = 100\text{mA}$		1.2		Ω
$I_{FB(LEAK)}$	Current Feedback Leakage	$V_{SHDN} = 3\text{V}$, $V_{FB} = V_I$		0.1	1	μA
Switch section						
R_{ON}	Internal Switch ON-Resistance	$I_{SW} = 1\text{A}$ <i>Note: 1</i>		0.3		Ω
$I_{SW(LEAK)}$	Internal Switch Leakage Current	$V_{SHDN} = 3\text{V}$, $V_{SW} = 16.5\text{V}$		0.1	1	μA
D_{MAX}	Maximum Duty Cycle	$I_{FB} = 0\text{mA}$		90		%
D_{MIN}	Minimum Duty Cycle	$I_{FB} = 200\text{mA}$; $V_{SEL} = 0\text{V}$ Pulse Skipping		0		%
Control input section						
$V_{H(SEL)}$ $V_{H(SHDN)}$	SEL and SHDN Input High Threshold	$V_I = 2.6\text{V}$	1.2			V
		$V_I = 3.6\text{V}$	1.4			
		$V_I = 5.5\text{V}$	1.6			
$V_{L(SEL)}$ $V_{L(SHDN)}$	SEL and SHDN Input Low Threshold	$V_I = 2.6\text{V}$			0.4	V
		$V_I = 3.6\text{V}$			0.5	
		$V_I = 5.5\text{V}$			0.6	
Thermal shutdown						
T_{SD}	Thermal Shutdown			145		$^{\circ}\text{C}$
T_{HS}	Thermal Shutdown Hysteresis			15		$^{\circ}\text{C}$

Note: 1 Typical value, not production tested

6 Detailed description

The STCF01 white Led boost converter drives from two up to four white LEDs with a constant current. It needs few external components: two ceramic capacitors ($C_1=2.2\mu\text{F}$ $C_O=4.7\mu\text{F}$), one inductor $L=10\mu\text{H}$ and one schottky diode. The device works with a minimum $V_I=2.6\text{V}$, and it has an Over Voltage Protection on the output guaranteed at minimum value equal to 17V. This value ensures proper operation with a maximum of four White LEDs in series. In the worst case of $V_I=2.6\text{V}$ at $V_{OVP}=8\text{V}$ (typical value of two LEDs) it is possible to obtain $I_O=270\text{mA}$, while at $V_{OVP}=11\text{V}$ (typical value of three LEDs) it is possible obtain $I_O=180\text{mA}$ (*Figure 4*). The maximum IO current is limited by inductor peak current internally set at Typ 1.2A. This feature allows for a longer battery life as it reduces intensive use of the flash. The SEL pin allows selection of high and low current values flowing on the White LEDs.

The two current values are set through external resistors R_{HC} and R_{LC} according to the following formula:

$$I_{LED(FLASH)} = 2100 * (V_I - V_{HC}) / R_{HC}$$

$$I_{LED(TORCH)} = 2400 * (V_I - V_{LC}) / R_{LC}$$

A High logic level on SHDN pin puts the device in shutdown mode; if it is held at LOW the flash or torch mode is activated. When the SHDN pin is LOW the device provides the requested current in less than 200 μs (see TURN ON TIME plot). This fast turn-on time makes the device suitable for single shoot and multiple shoot operation modes.

7 Typical operating characteristics

($T_J = -40^{\circ}\text{C}$ to 85°C , $V_I = 3.6\text{V}$, $C_I = 2.2\mu\text{F}$, $C_O = 4.7\mu\text{F}$, $L = 10\mu\text{H}$, $R_{LC} = 12\text{k}\Omega$, $R_{HC} = 4\text{k}\Omega$, $V_{OVP} = 8\text{V}$, Typ. values @ 25°C , unless otherwise specified).

Figure 4. Maximum output current vs input voltage

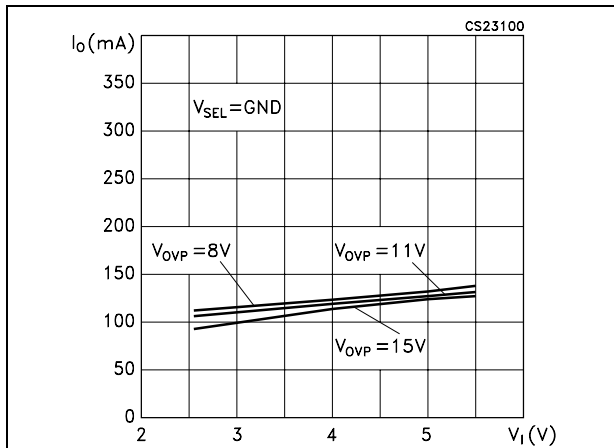

Figure 5. Maximum output current vs input voltage

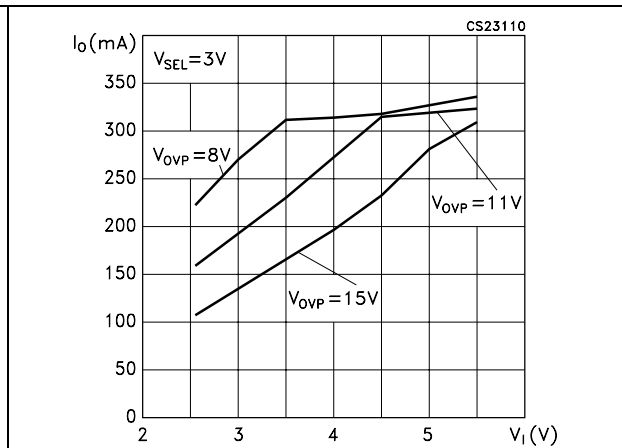

Figure 6. Efficiency vs temperature

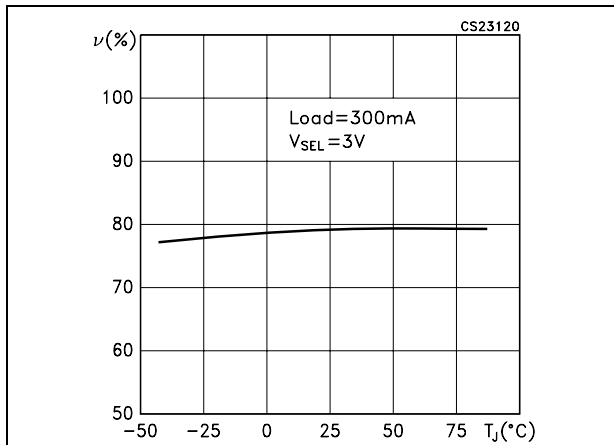

Figure 7. Efficiency vs temperature

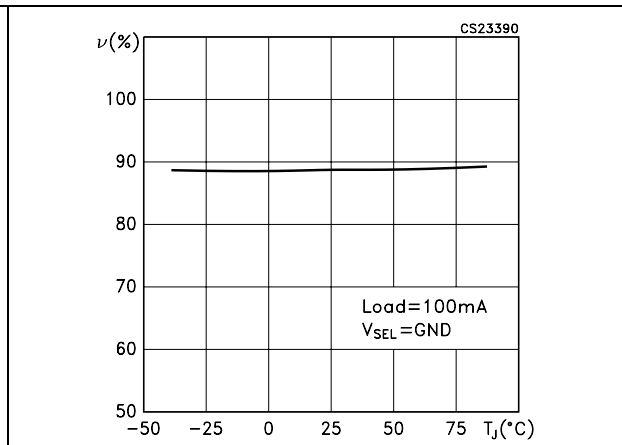

Figure 8. Efficiency vs temperature

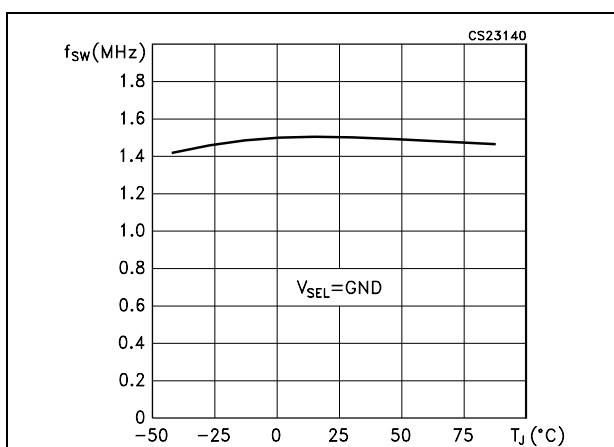

Figure 9. Quiescent current at full operation vs. temperature

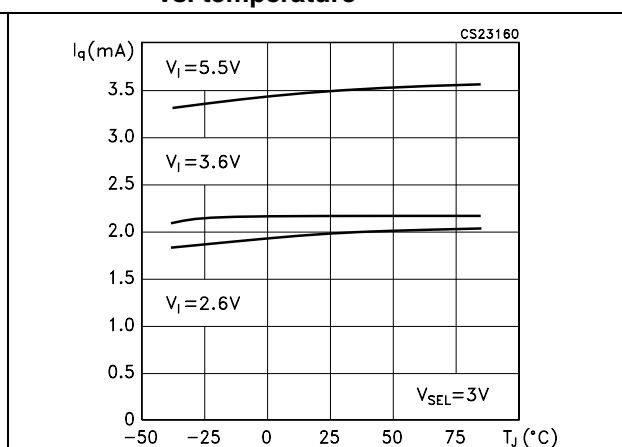

Figure 10. Feedback voltage vs temperature

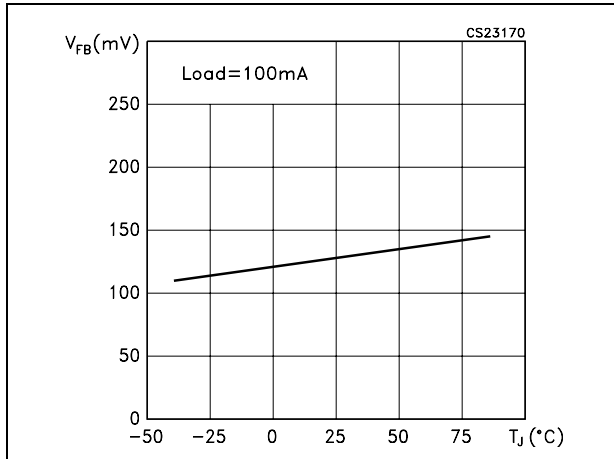

Figure 11. Current feedback leakage vs temperature

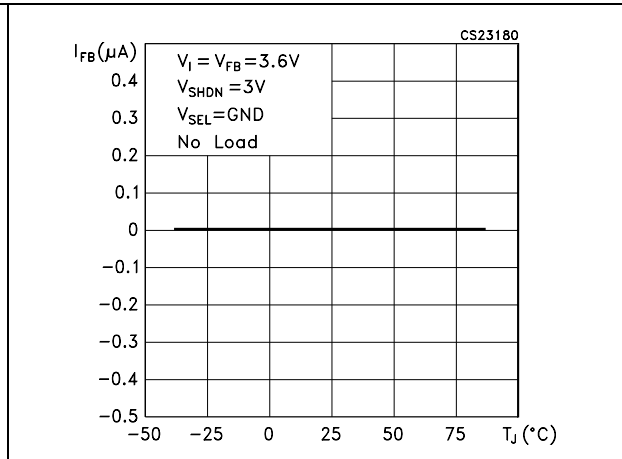

Figure 12. V_I-V_{LC} vs temperature

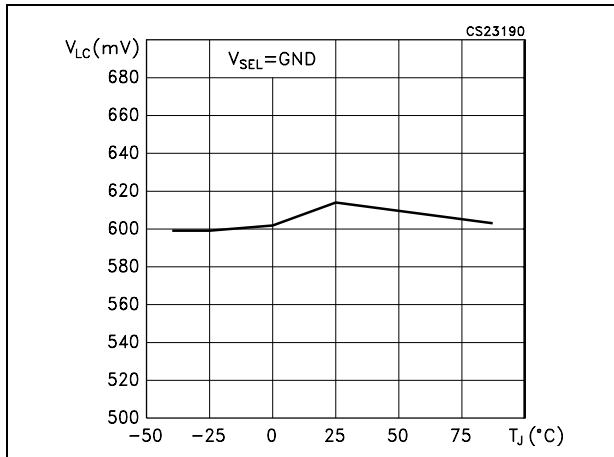

Figure 13. V_I-V_{HC} vs temperature

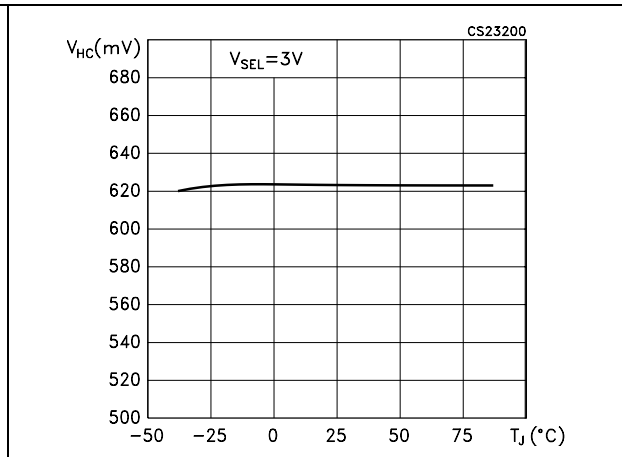

Figure 14. Peak inductor current vs temperature

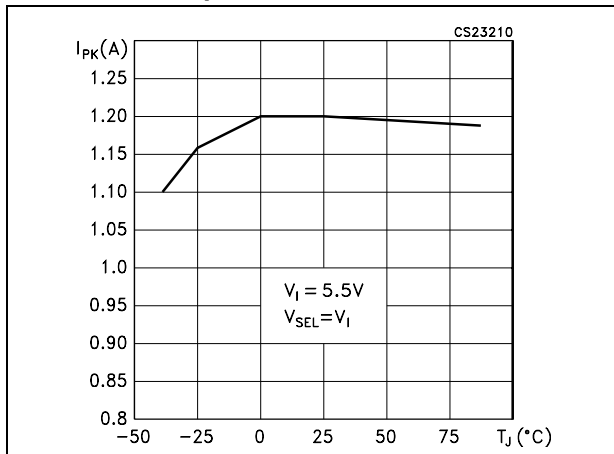

Figure 15. R_{ONFB} vs temperature

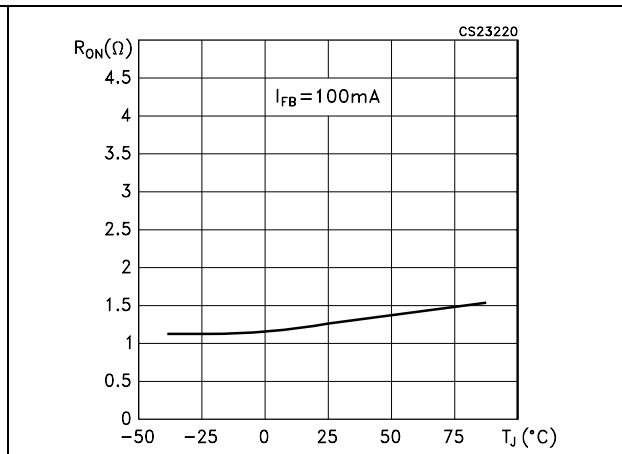

Figure 16. Maximum duty cycle vs temperature Figure 17. Turn on and off response

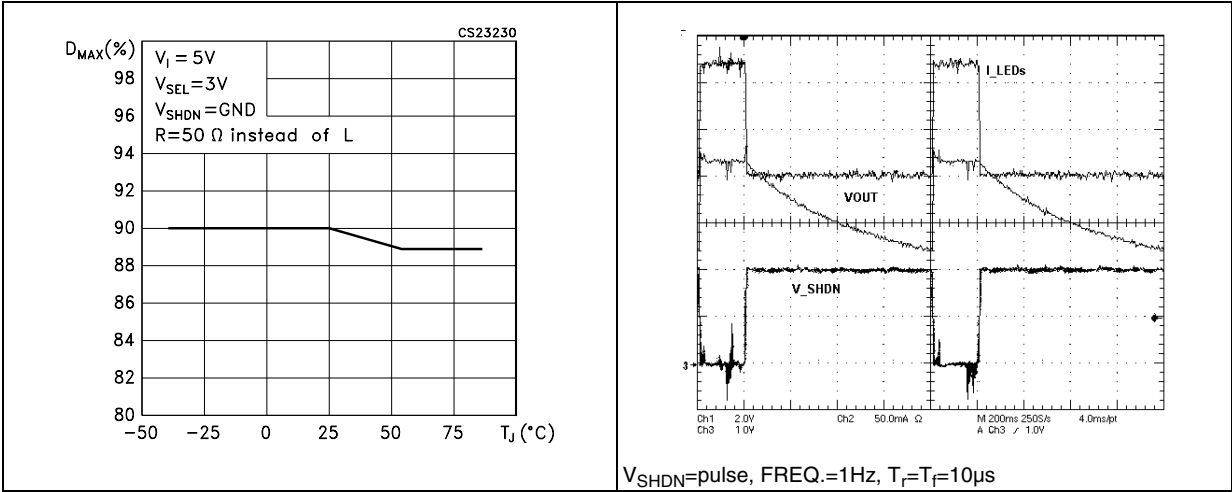

Figure 18. Turn on time

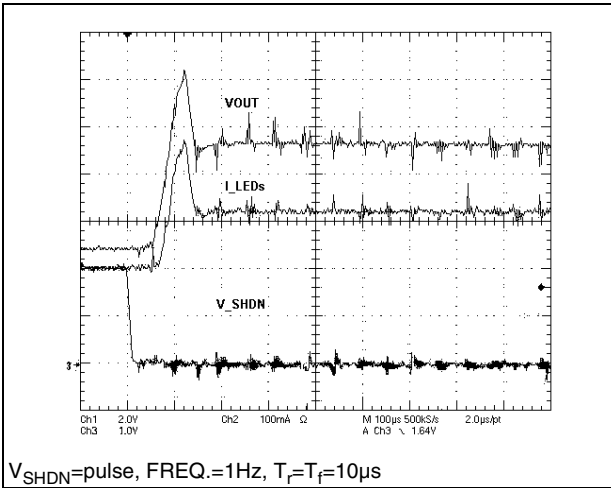

Figure 19. Start up transient

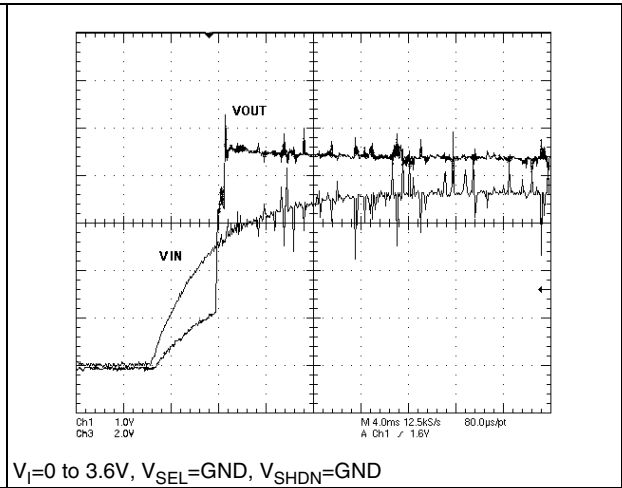

Figure 20. Multi shoot mode

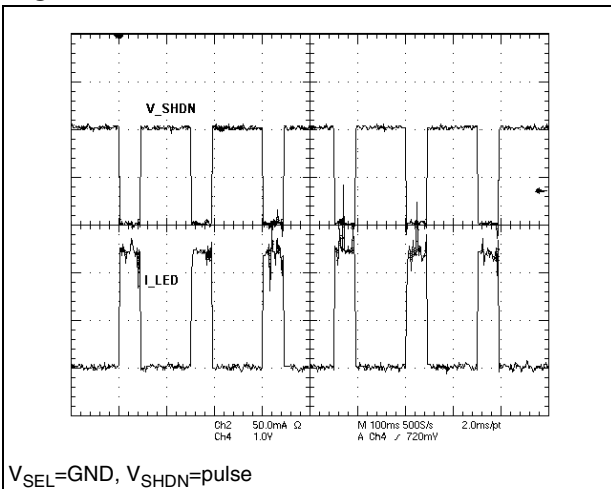
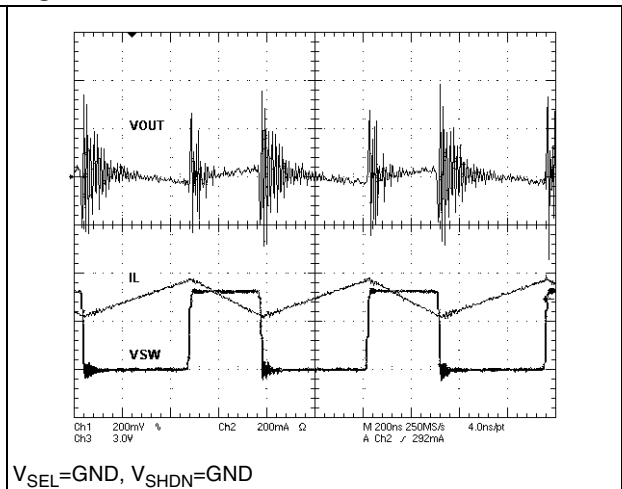

Figure 21. Torch mode behavior



8 Package mechanical data

In order to meet environmental requirements, ST offers these devices in ECOPACK® packages. These packages have a Lead-free second level interconnect. The category of second level interconnect is marked on the package and on the inner box label, in compliance with JEDEC Standard JESD97. The maximum ratings related to soldering conditions are also marked on the inner box label. ECOPACK is an ST trademark. ECOPACK specifications are available at: www.st.com.

DFN10 (3x3) MECHANICAL DATA

DIM.	mm.			mils		
	MIN.	TYP	MAX.	MIN.	TYP.	MAX.
A	0.80	0.90	1.00	31.5	35.4	39.4
A1		0.02	0.05		0.8	2.0
A2		0.70			25.6	
A3		0.20			7.9	
b	0.18	0.23	0.30	7.1	9.1	11.8
D		3.00			118.1	
D2	2.21	2.26	2.31	87.0	89.0	91.0
E		3.00			118.1	
E2	1.29	1.34	1.39	50.8	52.8	54.8
e		0.50			19.7	
L	0.45	0.55	0.65	17.7	21.7	25.6

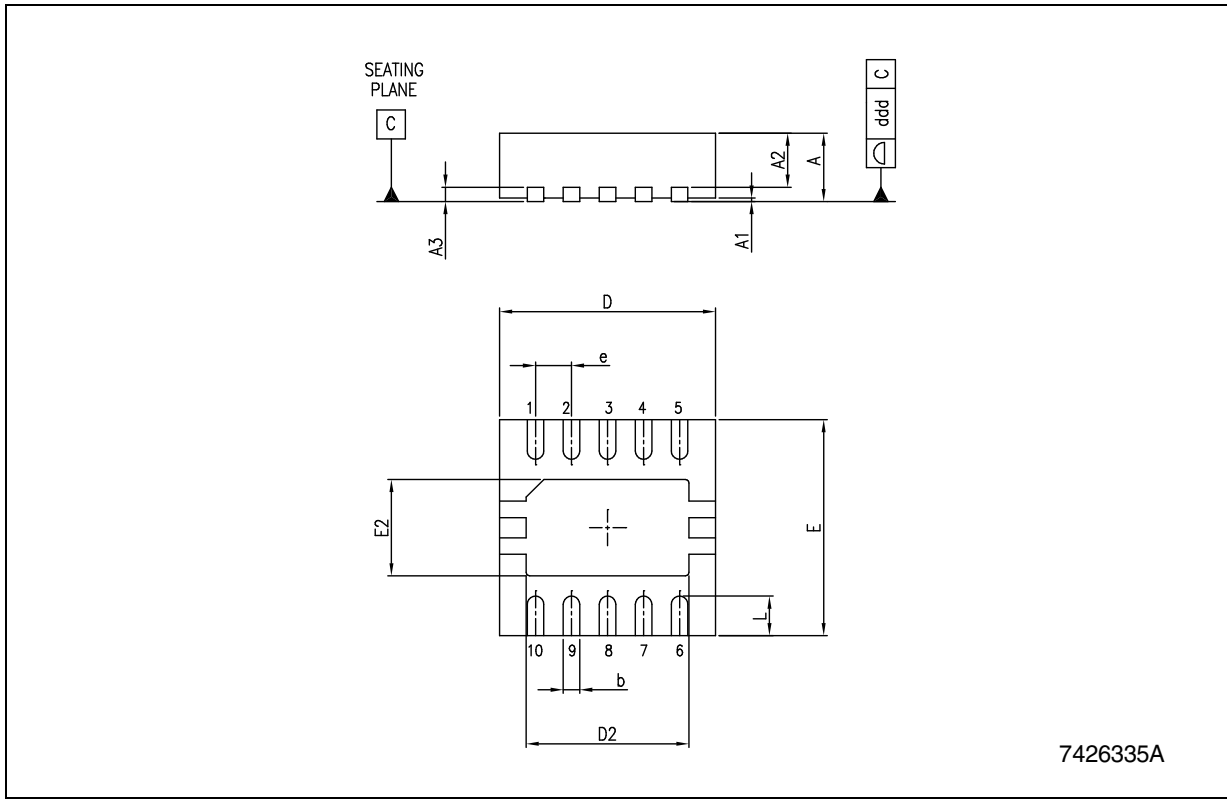

Tape & Reel QFNxx/DFNxx (3x3) MECHANICAL DATA

DIM.	mm.			inch		
	MIN.	TYP	MAX.	MIN.	TYP.	MAX.
A			330			12.992
C	12.8		13.2	0.504		0.519
D	20.2			0.795		
N	60			2.362		
T			18.4			0.724
Ao		3.3			0.130	
Bo		3.3			0.130	
Ko		1.1			0.043	
Po		4			0.157	
P		8			0.315	

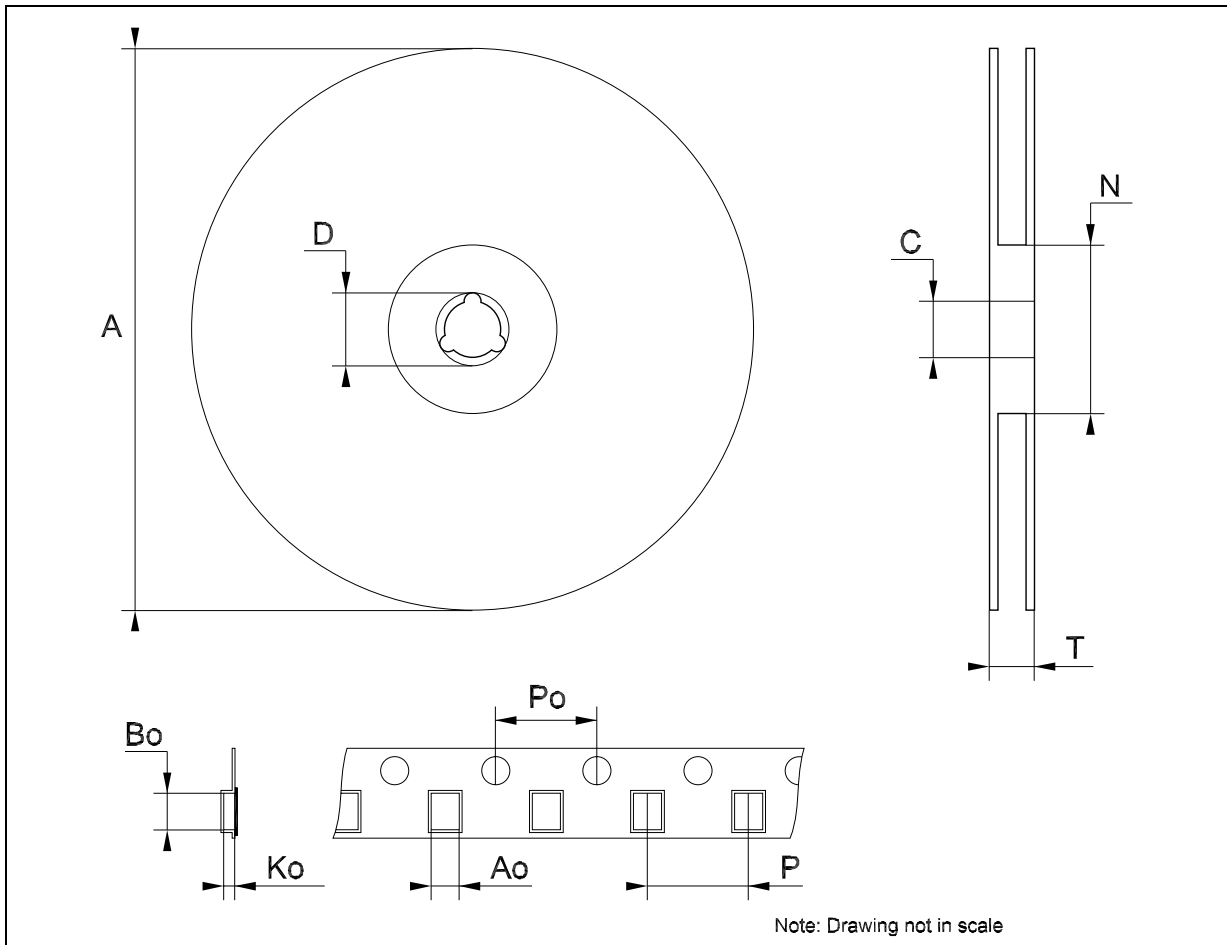

9 Revision history

Table 5. Revision history

Date	Revision	Changes
10-Oct-2005	1	First release.
28-Apr-2006	2	Maturity code has been changed.
27-Jul-2006	3	Change value in table 2 P_{TOT} .
18-Oct-2006	4	Text updates.

Please Read Carefully:

Information in this document is provided solely in connection with ST products. STMicroelectronics NV and its subsidiaries ("ST") reserve the right to make changes, corrections, modifications or improvements, to this document, and the products and services described herein at any time, without notice.

All ST products are sold pursuant to ST's terms and conditions of sale.

Purchasers are solely responsible for the choice, selection and use of the ST products and services described herein, and ST assumes no liability whatsoever relating to the choice, selection or use of the ST products and services described herein.

No license, express or implied, by estoppel or otherwise, to any intellectual property rights is granted under this document. If any part of this document refers to any third party products or services it shall not be deemed a license grant by ST for the use of such third party products or services, or any intellectual property contained therein or considered as a warranty covering the use in any manner whatsoever of such third party products or services or any intellectual property contained therein.

UNLESS OTHERWISE SET FORTH IN ST'S TERMS AND CONDITIONS OF SALE ST DISCLAIMS ANY EXPRESS OR IMPLIED WARRANTY WITH RESPECT TO THE USE AND/OR SALE OF ST PRODUCTS INCLUDING WITHOUT LIMITATION IMPLIED WARRANTIES OF MERCHANTABILITY, FITNESS FOR A PARTICULAR PURPOSE (AND THEIR EQUIVALENTS UNDER THE LAWS OF ANY JURISDICTION), OR INFRINGEMENT OF ANY PATENT, COPYRIGHT OR OTHER INTELLECTUAL PROPERTY RIGHT.

UNLESS EXPRESSLY APPROVED IN WRITING BY AN AUTHORIZED ST REPRESENTATIVE, ST PRODUCTS ARE NOT RECOMMENDED, AUTHORIZED OR WARRANTED FOR USE IN MILITARY, AIR CRAFT, SPACE, LIFE SAVING, OR LIFE SUSTAINING APPLICATIONS, NOR IN PRODUCTS OR SYSTEMS WHERE FAILURE OR MALFUNCTION MAY RESULT IN PERSONAL INJURY, DEATH, OR SEVERE PROPERTY OR ENVIRONMENTAL DAMAGE. ST PRODUCTS WHICH ARE NOT SPECIFIED AS "AUTOMOTIVE GRADE" MAY ONLY BE USED IN AUTOMOTIVE APPLICATIONS AT USER'S OWN RISK.

Resale of ST products with provisions different from the statements and/or technical features set forth in this document shall immediately void any warranty granted by ST for the ST product or service described herein and shall not create or extend in any manner whatsoever, any liability of ST.

ST and the ST logo are trademarks or registered trademarks of ST in various countries.

Information in this document supersedes and replaces all information previously supplied.

The ST logo is a registered trademark of STMicroelectronics. All other names are the property of their respective owners.

© 2006 STMicroelectronics - All rights reserved

STMicroelectronics group of companies

Australia - Belgium - Brazil - Canada - China - Czech Republic - Finland - France - Germany - Hong Kong - India - Israel - Italy - Japan - Malaysia - Malta - Morocco - Singapore - Spain - Sweden - Switzerland - United Kingdom - United States of America

www.st.com